

# Battery Cartridge Replacement

Back-UPS or BK (200 - 500 VA) and  
Back-UPS Pro, BK Pro or SU (280 - 420 VA)

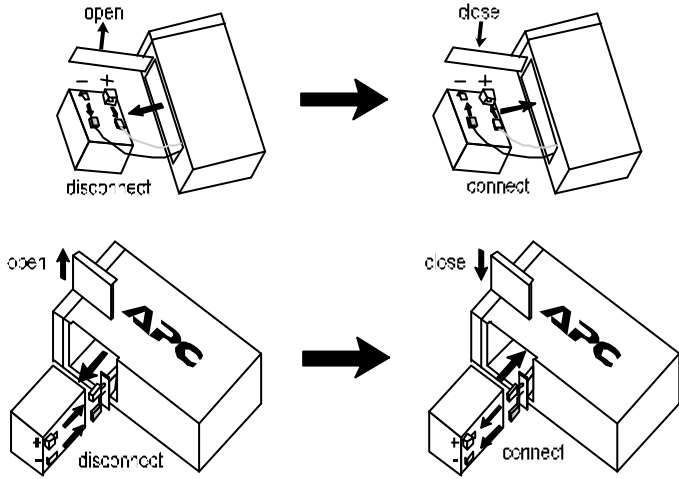

Back-UPS Pro USB (350, 500, and 650 VA)

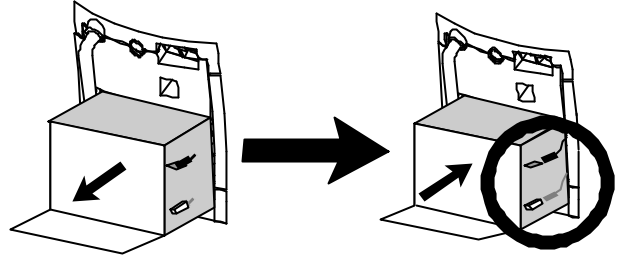

Back-UPS (1000 and 1400 VA)

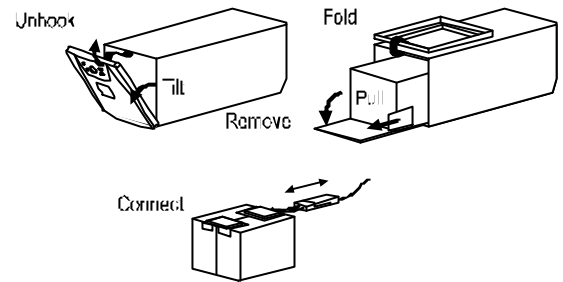

Smart-UPS (450 - 1500 VA) and  
Smart-UPS XLBP

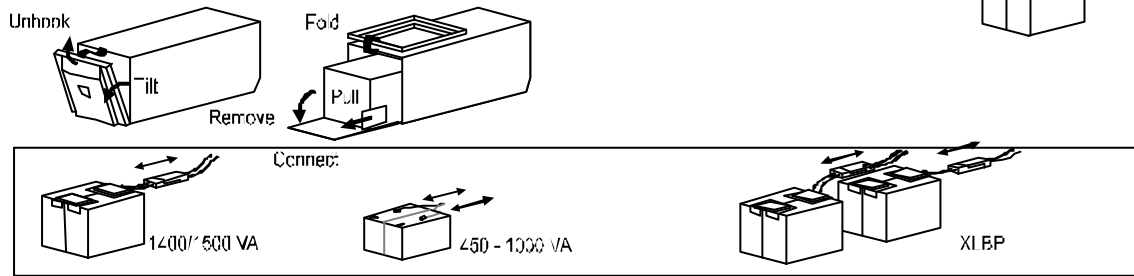

Back-UPS Office (250 - 500 VA)

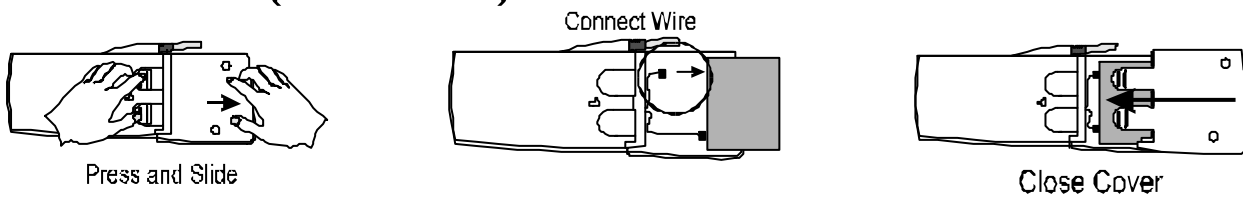

## Back-UPS ES 350 and ES 500

remove screw

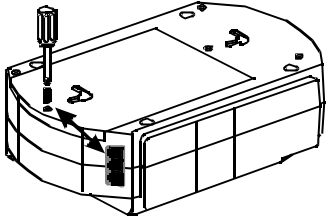

slide cover off

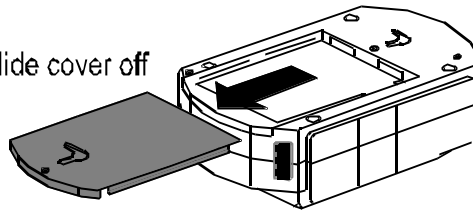

disconnect wires, replace with new battery and reconnect wires.

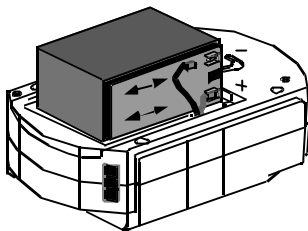

Back-UPS ES 500

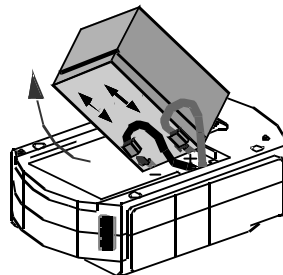

Back-UPS ES 350

Close cover and  
reinstall screw

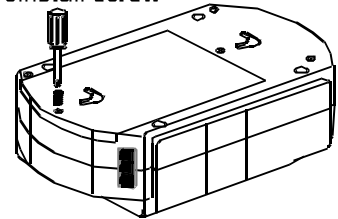

## Back-UPS ES 725

press release tabs and slide off cover

release tabs

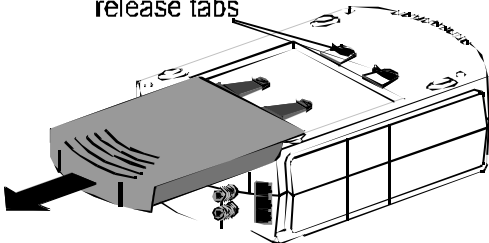

disconnect wires, replace with new battery  
and reconnect wires.

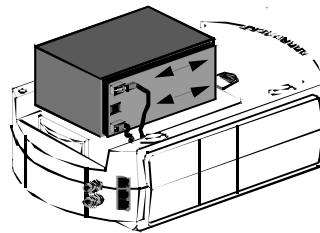

close cover

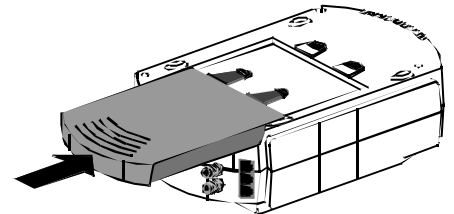

## Back-UPS ES 400/550/700

press release tabs and slide off cover

release tabs

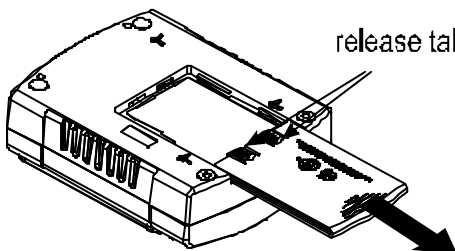

disconnect wires, replace with new battery  
and reconnect wires.

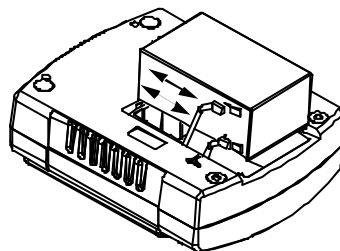

close cover

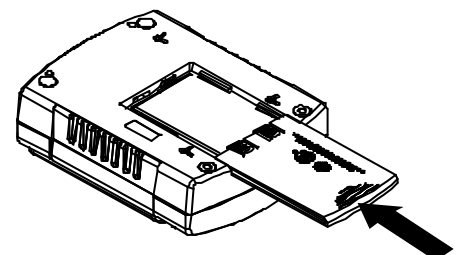

## Smart-UPS Rackmount (all 5.25" tall models)

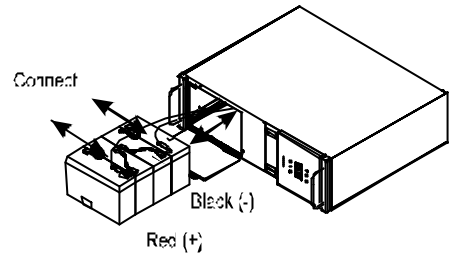
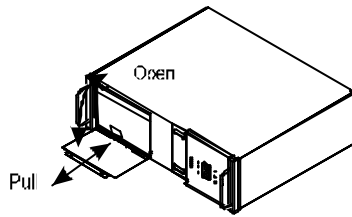
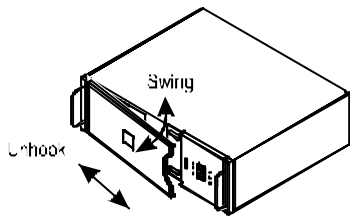

MODELS 700-1400

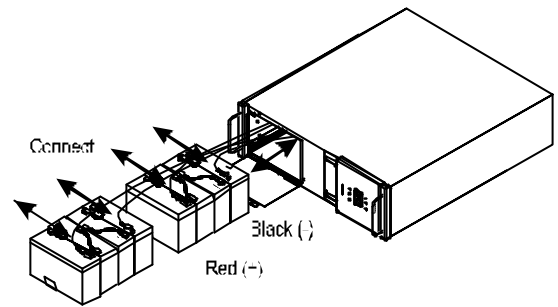

MODELS 2200-3000

## Smart-UPS Rackmount (all 8.75" tall models)

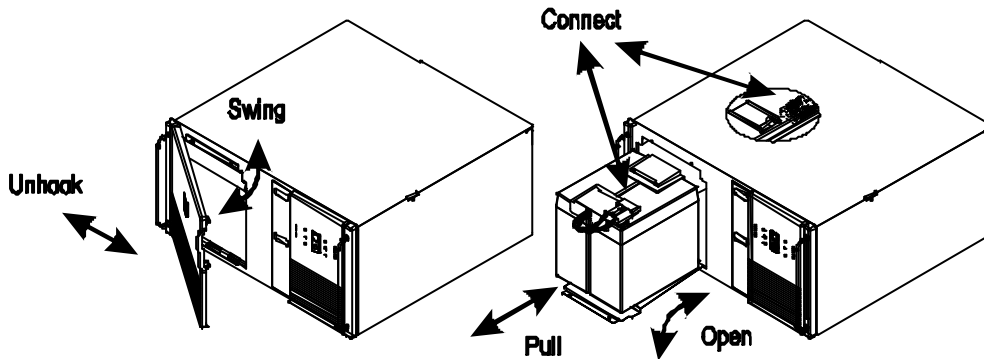

## Smart-UPS Rackmount XL Battery Packs

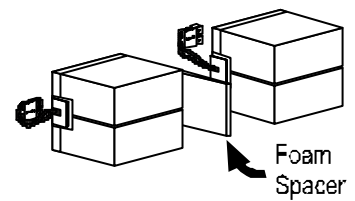
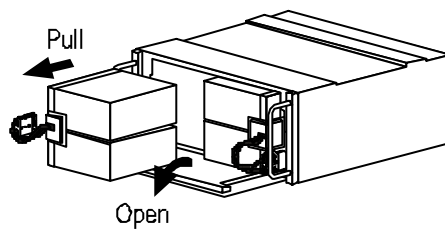
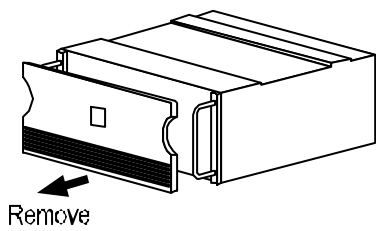

Smart-UPS (2200 and 3000 VA)

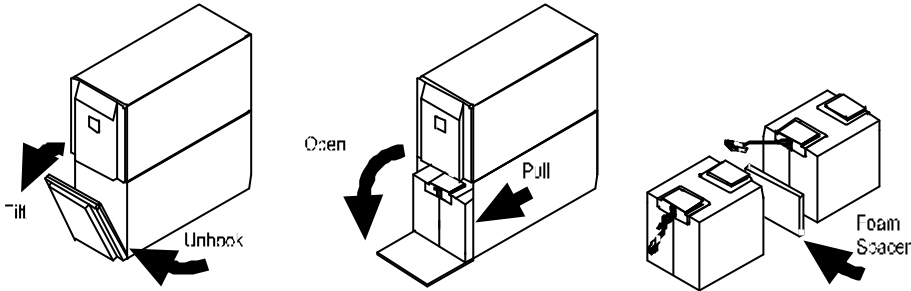

UXBP (24, 48, 48M)

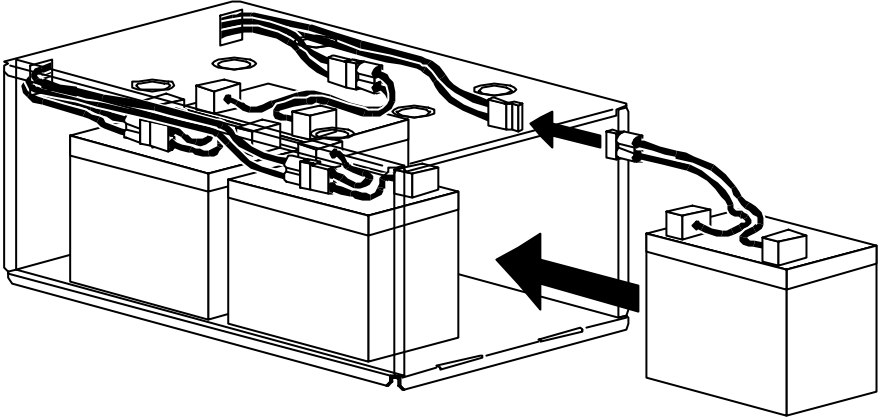

SmartCell XR

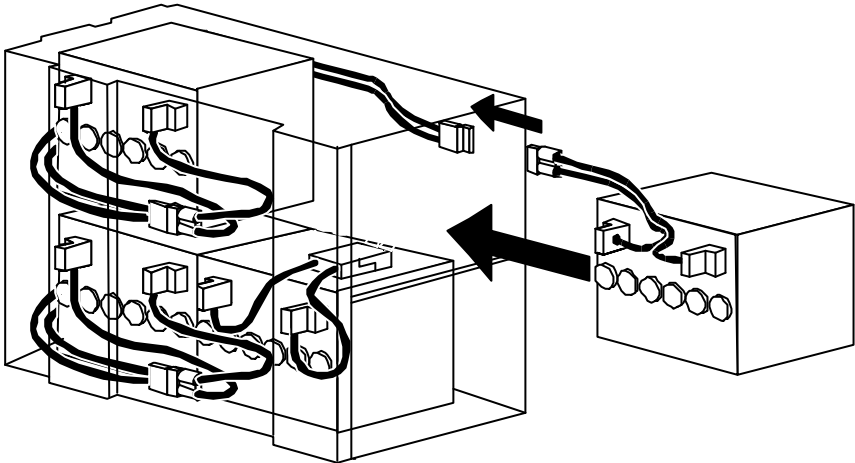

Dispose

